

→ cilindric

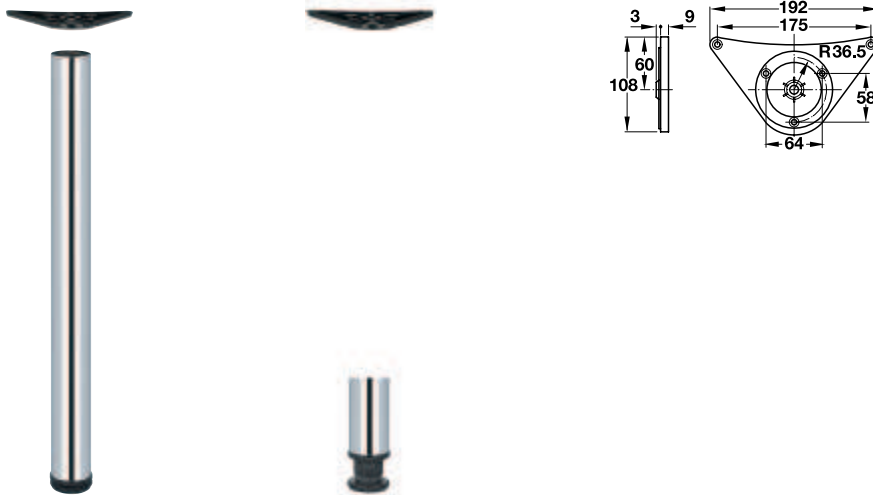

ambalate ca set, în carton cu fereastră



ajustare pe înălțime



Înălțime constructivă mm	Diametru mm	Suprafață/culoare	Nr. articol
710	60	aluminiu alb, RAL 9006	635.24.271
		cromat lucios	635.24.273
		negru	635.24.371
		de culoarea inoxului, lăcuit clar	635.24.471

Ambalaj: 4 bucăți

→ cilindric, curbat

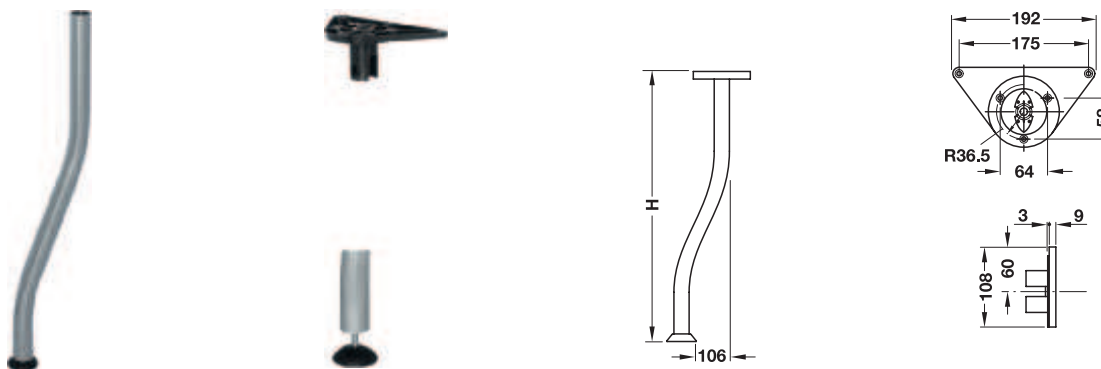

- Material: plăcuță de înșurubare: zinc turnat sub presiune
- Culoare: plăcuță de înșurubare: gri închis
- ajustare pe înălțime: +15 mm



Înălțime de construcție H mm	Diametru mm	Suprafață	Nr. articol
710	40	aluminiu alb, RAL 9006	635.66.270

Ambalaj: 4 bucăți

→ pătrat



ambalate ca set, în carton cu fereastră

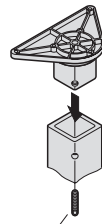

șurub de fixare
M10 cu filet
interior
hexagonal SW 4

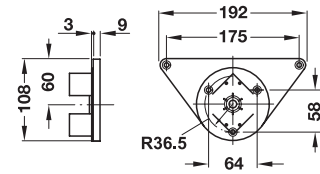

- ajustare pe înălțime: +25 mm



Înălțime constructivă mm	Secțiune mm	Suprafață/culoare	Nr. articol
710	60 x 60	cromat lucios	635.59.271
		cromat mat	635.59.671
		lăcuit clar, culoarea inoxului	635.59.471
		aluminu alb, RAL 9006	635.59.272
		negru	635.59.371

Ambalaj: 4 bucăți

→ conic



ambalate ca set, în carton cu fereastră

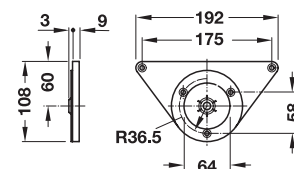
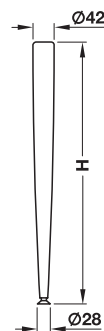

- ajustare pe înălțime: +10 mm
- Execuție: cu talpă de picior mobilă



Înălțime de construcție H mm	Diametru mm	Suprafață/culoare	Nr. articol
710	42	cromat lucios	635.44.271
		lăcuit clar, culoarea inoxului	635.44.671
		aluminu alb, RAL 9006	635.44.971

Ambalaj: 4 bucăți

Adaptor pentru blat din sticlă

► FF 10.91

→ conic



ambalate ca set, în carton cu fereastră

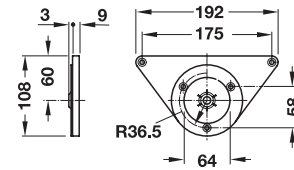
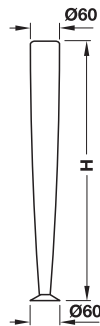

- ajustare pe înălțime: +15 mm
- Execuție: cu talpă de picior mobilă



Înălțime constructivă H mm	Diametru mm	Suprafață/culoare	Nr. articol
710	60	cromat lucios	635.49.271
		lăcuit clar, culoarea inoxului	635.49.671
		aluminu alb, RAL 9006	635.49.971

Ambalaj: 4 bucăți

Adaptor pentru blat din sticlă

► FF 10.91

→ conic, pliant

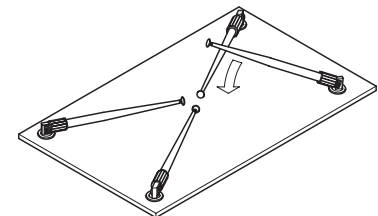
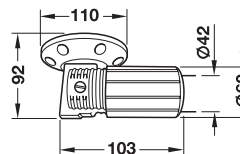

- Material: mecanism de rabatare: zinc turnat sub presiune
- Culoare: picior de masă: aluminu alb, RAL 9006
piesă de capăt: negru
- ajustare pe înălțime: +15 mm



Înălțime constructivă mm	Diametru mm	Nr. articol
710	50,0	635.64.271

Ambalaj: 4 bucăți

pătrat
cu plăcuță



și pentru înălțimea mesei de canapea



montaj în colț



montaj în mijloc

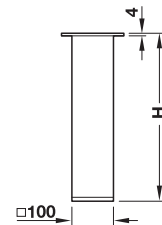
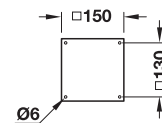
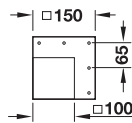

- Material: glisor: plastic
- Suprafață: picior de masă: lăcuit, de culoarea aluminiului RAL 9006
glisor: negru



Înălțime de construcție H mm	Nr. articol	Nr. articol
400	635.02.264	635.02.274
720	635.02.267	635.02.277

Ambalaj: 4 bucăți

curbat
→ conic

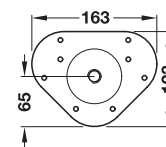

- Material: glisor din oțel și plastic, plăcuță de înșurubare din oțel
- Culoare: glisor: negru, plăcuță de înșurubare: gri închis
- ajustare pe înălțime: +15 mm

Set de livrare

1 picior de masă cu material de fixare



Înălțime de construcție H mm	Diametru mm	Suprafață	Nr. articol
710	60	cromat lucios	635.42.272
		nichelat mat	635.42.672

Ambalaj: 4 bucăți